

Thermostatic mixing valves with replaceable cartridge for centralized systems

series 5230



01080/11 NA

Replaces 01080/09 NA



BS EN ISO 9001:2008
Cert. n° FM 21654



UNI EN ISO 9001:2000
Cert. n° 0003



Function

The thermostatic mixing valve is used in systems producing domestic hot water or in radiant panel heating systems. Its function is to maintain the temperature of the mixed water supplied to the user at a constant set value when there are variations in the supply pressure and temperature of the incoming hot and cold water or in the flow rate.

Valve models with integral inlet port check valves are ASSE 1070 approved for point of use installations. Models without check valves are ASSE 1017 approved for point of distribution and are designed specifically for systems requiring high flow rates and precise, stable temperature control. Patent Pending N. MI2001A001645.



ASSE 1017

ASSE 1070

Product Range

Code 5230_0A Thermostatic mixing valve (ASSE 1017) with replaceable cartridge and threaded connections _____ sizes 1", 1-1/4", 1-1/2", 2"
 Code 5230_6A Thermostatic mixing valve (ASSE 1017) with replaceable cartridge and sweat connections _____ size 1"
 Code 5230_8A Thermostatic mixing valve (ASSE 1017) with replaceable cartridge and sweat connections _____ sizes 3/4", 1", 1-1/4"
 Code 5230_5A Thermostatic mixing valve (ASSE 1070) with replaceable cartridge and threaded connections _____ sizes 3/4" and 1"
 Code 5230_7A Thermostatic mixing valve (ASSE 1070) with replaceable cartridge and sweat connections _____ sizes 3/4" and 1"
 Code 523005, 523006, 523008 Replacement cartridges for Thermostatic mixing valves

Technical specification

Materials: - Body: Brass
 - Shutter: Brass, chemical nickel plated
 - Springs: Stainless steel
 - Seals: EPDM

Medium: Water
 Maximum percentage of glycol: 30% glycol solution

Setting range:
 See table on page 3

Temperature stability: ± 5°F (± 3°C)
 Max working pressure (static): 200 psi (14 bar)
 Max working pressure (dynamic): 70 psi (5 bar)
 Hot water inlet temperature range: 120 – 185°F (49 – 85°C)
 Cold water inlet temperature range: 40 – 80°F (4.4 – 26.6°C)
 Maximum inlet pressure ratio (H/C or C/H): 2:1
 Minimum temperature difference between hot water inlet and mixed water outlet for optimum performance: 20°F (11°C)
 Maximum water hardness: 10 grains
 Approved for ASSE 1017 and 1070 depending on model

Dimensions

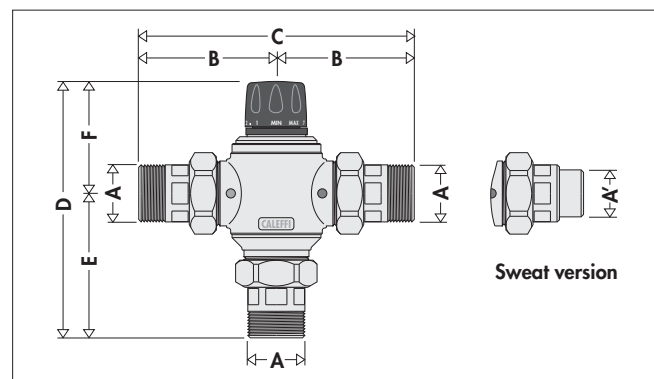

	Code	A	B	C	D	E	F	Weight (lb)
ASSE 1070	523055A	3/4" NPT	3 5/16"	7 7/8"	7 3/16"	4 1/8"	2 15/16"	5
	523057A	3/4" SWT	3 5/16"	7 7/8"	5 15/16"	3"	2 15/16"	5
	523065A	1" NPT	3 13/16"	7 5/8"	7 1/16"	4 1/8"	2 15/16"	5
	523067A	1" SWT	3 5/16"	7 7/8"	6 3/16"	3 1/4"	2 15/16"	5
ASSE 1017	523058A	3/4" SWT	2 3/4"	5 1/2"	6 1/8"	3 1/4"	2 15/16"	5
	523066A	1" SWT	2 15/16"	5 7/8"	6 5/16"	3 7/16"	2 15/16"	5
	523060A	1" NPT	4 7/16"	8 7/8"	8 1/16"	4 5/8"	3 7/16"	7
	523068A	1" SWT	3 9/16"	7 1/8"	7 3/16"	3 3/4"	3 7/16"	6,5
	523070A	1 1/4" NPT	4 5/8"	9 5/16"	8 1/4"	4 13/16"	3 7/16"	7
	523078A	1 1/4" SWT	3 11/16"	7 5/16"	7 5/16"	3 13/16"	3 7/16"	6,5
	523080A	1 1/2" NPT	5 3/16"	10 5/16"	9 3/4"	5 1/2"	4 1/4"	17
523090A	2" NPT	5 3/16"	10 3/8"	9 3/4"	5 1/2"	4 1/4"	18	

“Legionella” - Scalding risk

In systems producing domestic hot water with storage, in order to avoid the dangerous infection known as “*Legionella*”, the hot water must be stored at a temperature of at least 140°F. At this temperature it is certain that the growth of the bacteria causing this infection will be totally eliminated. However, at this temperature the water cannot be used directly, as it may cause scalding. For example, at 130°F, partial burning takes place in 30 seconds and at 140°F total burning takes place in 5 seconds. In view of the above, it is necessary to install a thermostatic mixing valve which can:

- reduce the temperature at the point of use to a value lower than that of storage;
- maintain this value when the incoming pressure and temperature conditions vary.

Thermal disinfection

The diagram below shows the behavior of the bacteria “*Legionella Pneumophila*” when the temperature conditions of the water in which it is contained vary, in laboratory sample population. In order to ensure proper thermal “disinfection”, the value must not be below 140°F.

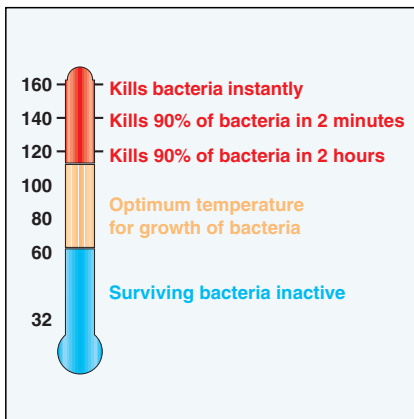

Reference documents

With regard to the prevention and control of Legionella, see the National Regulations and applicable Code of Practice.

Principle of Operation

A thermostatic mixing valve mixes hot and cold water in such a way as to maintain a constant set temperature of the mixed water at the outlet.

A thermostatic element is fully immersed into the mixed water. It then contracts or expands causing movement of the piston, closing either the hot or cold inlets, regulating the flow rates entering the valve. If there are variations of temperature or pressure at the inlets, the internal element automatically reacts attempting to restore the original temperature setting.

Thermal shutoff

In the event of a failure of either the hot or cold supply, the piston will shut off, stopping water discharging from the mixed water outlet.

The Caleffi valve requires a minimum temperature differential from hot inlet to mixed water outlet of 20°F (11°C) to ensure the correct operation of the thermal shutoff feature.

Constructional details

Double seat

The mixing valve has a special actuator which acts on a double water passage seat. This guarantees a high flow rate with a reduced resistance, at the same time maintaining accurate temperature regulation.

Replaceable cartridge

The internal cartridge containing all the regulating components is pre-assembled in a single unit and can easily be inspected for cleaning or replacement if necessary, without the need to remove the valve body from the pipework.

Anti-wear surfaces

All the working parts such as shutter, seats and slide guide are chemical nickel plated. This treatment reduces the wearing and scaling to a minimum and guarantees the maintenance of performance over time.

Low inertia thermostat

The temperature-sensitive element, the “motor” of the thermostatic mixing valve, is characterised by a low heat inertia; this means that it reacts rapidly to variations in the incoming temperature and pressure conditions, reducing the valve response times.

Temperature setting and locking

The control knob permits temperature setting, between min. and max., in one turn (360°). It also has a tamper-proof system to lock the temperature at the set value.

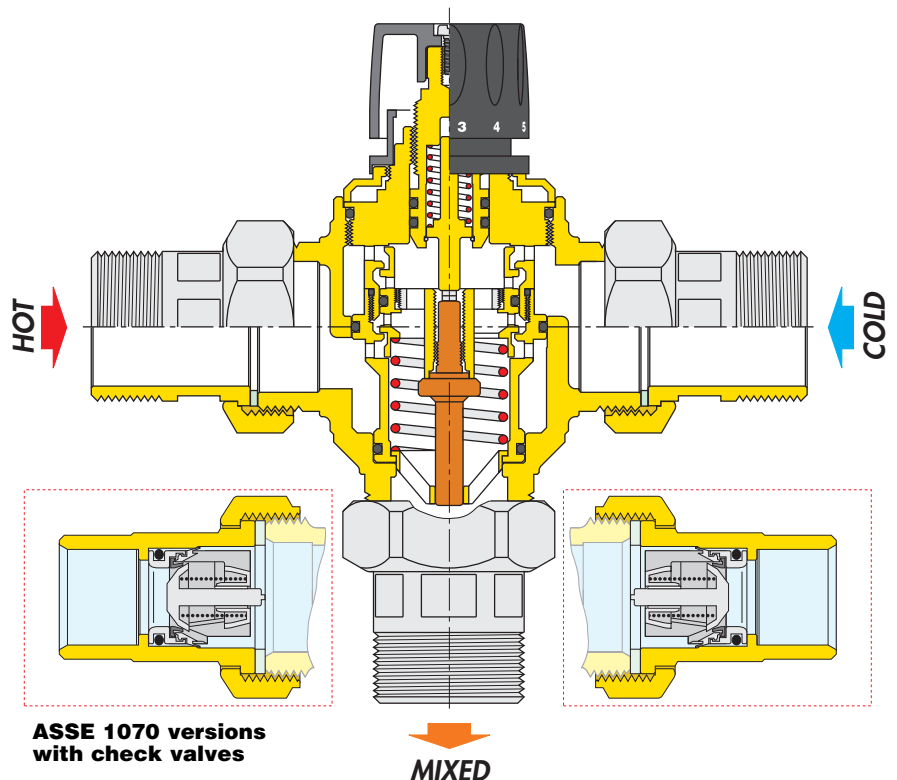

Point of Use ASSE 1070 Approved

(packaged with pipe fittings and check valves)

Code	Description	Flow
523055A	3/4" Union Thread NPT male	4.8 Cv
523057A	3/4" Union Sweat	4.8 Cv
523065A	1" Union Thread NPT male	4.8 Cv
523067A	1" Union Sweat	4.8 Cv

Setting the temperature
The temperature is set to the required value by means of the adjusting knob with the graduated scale on the top of the valve.

Pos.	Min	1	2	3	4	5	6	7	Max
T (°F)	77	84	91	102	109	118	126	136	149
T (°C)	25	29	33	39	43	48	52	58	65

with: $T_{HOT} = 155^{\circ}F (68^{\circ}C)$ · $T_{COLD} = 55^{\circ}F (13^{\circ}C)$ · $P = 43 \text{ psi (3 bar)}$

Replacement Cartridge code 523005

Flow curve

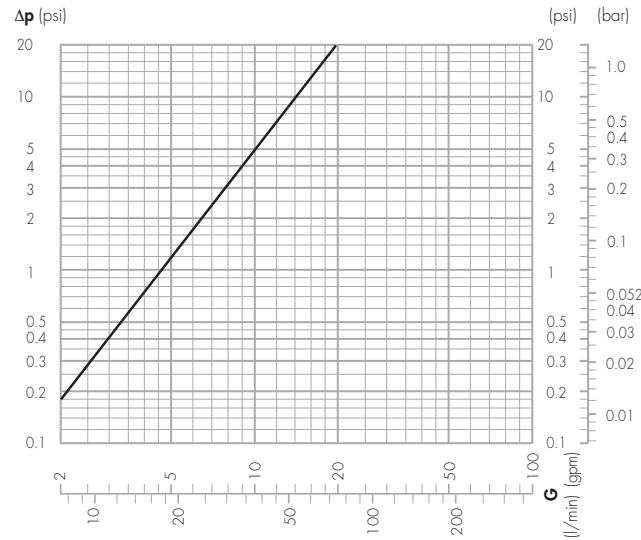

Recommended flow rates for temperature stability:

	Min. (gpm)	Max. (gpm)
3/4" - 1"	2	24

3/4, and 1 inch sizes use the same body, differing only by inlet/outlet fittings, have the same max Cv of 4.8 and one flow curve.

Point of Distribution ASSE 1017 Approved

Code	Description	Flow
523058A	3/4" Union Sweat	4.8 Cv
523066A	1" Union Sweat	4.8 Cv

Setting the temperature
The temperature is set to the required value by means of the adjusting knob with the graduated scale on the top of the valve.

Pos.	Min	1	2	3	4	5	6	7	Max
T (°F)	77	84	91	102	109	118	126	136	149
T (°C)	25	29	33	39	43	48	52	58	65

with: $T_{HOT} = 155^{\circ}F (68^{\circ}C)$ · $T_{COLD} = 55^{\circ}F (13^{\circ}C)$ · $P = 43 \text{ psi (3 bar)}$

Replacement Cartridge code 523005

Code	Description	Flow
523060A	1" Union Thread NPT male	8 Cv
523068A	1" Union Sweat	8 Cv
523070A	1-1/4" Union Thread NPT male	10 Cv
523078A	1-1/4" Union Sweat	10 Cv

Pos.	Min	1	2	3	4	5	6	7	Max
T (°F)	81	90	100	111	120	127	136	145	153
T (°C)	27	32	38	44	49	53	58	63	67

with: $T_{HOT} = 155^{\circ}F (68^{\circ}C)$ · $T_{COLD} = 55^{\circ}F (13^{\circ}C)$ · $P = 43 \text{ psi (3 bar)}$

Replacement Cartridge code 523006

Code	Description	Flow
523080A	1-1/2" Union Thread NPT male	17 Cv
523090A	2" Union Thread NPT male	22 Cv

Pos.	Min	1	2	3	4	5	6	7	Max
T (°F)	97	102	108	113	118	126	129	135	140
T (°C)	36	39	42	45	48	52	54	57	60

with: $T_{HOT} = 155^{\circ}F (68^{\circ}C)$ · $T_{COLD} = 55^{\circ}F (13^{\circ}C)$ · $P = 43 \text{ psi (3 bar)}$

Replacement Cartridge code 523008

Flow curve

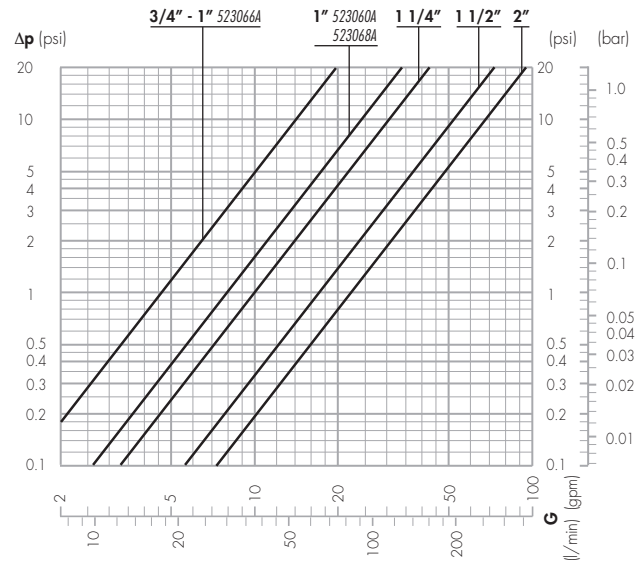

Recommended flow rates for temperature stability:

	Min. (gpm)	Max. (gpm)
3/4" - 1" (523066A)	2	24
1" 523060A - 523068A - 1 1/4"	4.5	40
1 1/2" - 2"	13	83

Use

Caleffi 5230 series thermostatic mixing valves are designed to be installed at the hot water heater (ASSE 1017 models) or at the point of distribution (ASSE 1070 models).

ASSE 1017 models are designed to be installed at the hot water heater and cannot be used for tempering water temperature at fixtures as a point-of-use valve. They are not designed to provide scald protection or anti-chill service and should not be used where ASSE 1070 devices are required. Wherever a scald protection feature is required, ASSE 1070 model mixing valves need to be installed. For safety reasons, it is advisable to limit the maximum mixed water temperature to 120°F.

ASSE 1070 models are suitable for point of use application. For this reason the flow rate through the valve is the same as that of the final outlet, e.g. mixing valve or tap for washbasin, shower or bath. The system must be sized taking into account the current legislation with regard to the nominal flow rate of each outlet.

Instantaneous production of hot water

Caleffi 5230 series thermostatic mixing valves should not be used in conjunction with boilers giving instantaneous production of domestic hot water. Their addition would compromise the correct operation of the boiler itself.

Radiant panel heating systems

Caleffi Series 5230 thermostatic mixing valves can also be used for regulating the flow temperature in radiant panel heating systems, to which it assures a constant and accurate control with ease of installation.

Installation

Before installing a Caleffi 5230 series thermostatic mixing valve, the system must be inspected to ensure that its operating conditions are within the range of the mixing valve, checking, for example, the supply temperature, supply pressure, etc.

Systems where the Caleffi 5230 series thermostatic mixing valve is to be fitted must be drained and cleaned out to remove any dirt or debris which may have accumulated during installation.

Failure to remove dirt or debris may affect performance and the manufacturer's product guarantee. Softened water use is highly recommended as the warranty is voided if used on water with hardness greater than 10 grains. The installation of filters of appropriate capacity at the inlet of the water from the mains supply is always advisable.

In areas which are subject to highly aggressive water, arrangements must be made to treat the water before it enters the valve.

Caleffi 5230 series thermostatic mixing valves must be installed in accordance with the diagrams in this manual, taking into account all current applicable standards.

Caleffi 5230 series thermostatic mixing valves can be installed in any position, either vertical or horizontal.

The following are shown on the thermostatic mixing valves body:

- Hot water inlet, color red.
- Cold water inlet, color blue.
- Mixed water outlet, marked "MIX".

In systems with thermostatic mixing valves, check valves must be installed to prevent undesirable fluid backflow. The 5230- 1017 models do not contain integral check valves, so those must be sourced separately. The 5230 - 1070 models come with check valves that must be installed in the field. See Installation instructions.

It is essential that access to the valve is totally unobstructed for any maintenance which may be required to the valve or connections. The pipework from/to the valve must not be used to support the weight of the valve itself.

Field installation of check valves provided with the Caleffi 5230 models approved for ASSE 1070: Check valves prevent the backflow of hot water into the cold branch, and cold water into the hot branch through the 5230 valve. Union sweat connections should be soldered prior to assembly to the valve, or without the sealing gasket or plastic check valve present. The sweat tailpiece must be soldered onto the piping, then cooled down before the check valves are installed. A moistened rag works well for cooling and cleaning the soldered joints. Be sure to slide the nut onto the tailpiece before it is placed on the tube and soldered. Do not attempt to solder or heat the sweat connection with the check valves or the thermostatic mixing valve installed. Also, flush any solder or flux residue from the piping before assembling the check and valve into the piping.

Commissioning

After installation, the valve must be tested and commissioned in accordance with the instructions given below, taking into account current applicable standards.

- 1) Ensure that the system is clean and free from any dirt or debris before commissioning the thermostatic mixing valves. Be sure water hardness is less than 10 grains.
- 2) It is recommended that the temperature is set using a suitable calibrated digital thermometer. The valve must be commissioned by measuring the temperature of the mixed water at the outlet.
- 3) The maximum outlet temperature from the valve must be set taking account of the fluctuations due to simultaneous use.
It is essential for these conditions to be stabilised before commissioning.
- 4) Adjust the temperature using the adjusting knob on the valve.
For safety reasons, it is advisable to limit the maximum mixed water temperature to 120°F in domestic hot water systems.

Temperature setting

The temperature is set to the required value by means of the knob with the graduated scale, located on the top of the valve.

Locking the setting

Position the knob at the required value, unscrew the top screw, slide off the knob and put it back in such a way that the handle fits into the internal slot of the knob. Tighten the head screw.

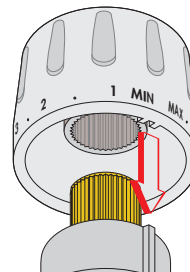

Replacing the cartridge

The internal cartridge, containing all the regulating components, can be inspected and, if necessary, replaced, without the need to dismantle the valve body from the pipework.

- 1) Close the shut-off valves on the hot and cold inlets. Set the knob to the maximum value.
- 2) Remove the temperature regulating knob after unscrewing the lock screw at the top. Dismantle the plastic knob frame. Unscrew the brass plated protective cover by means of the hexagon (1" - 1 1/4").
- 3) Remove the internal cartridge for inspection or replacement, using a suitably sized spanner.
- 4) Refit the protective brass plated cover. Refit the plastic frame in such a way that the position indicator is visible.
- 5) The spare cartridge is supplied pre-set to the maximum value. Position the regulating knob in such a way that the letters MAX align with the position indicator. By rotating the knob clockwise, it should be possible to adjust the value from maximum to minimum. Fix the knob with the top lock screw.
- 6) Reopen the shut-off valves and adjust the thermostatic mixing valves to the required temperature value.

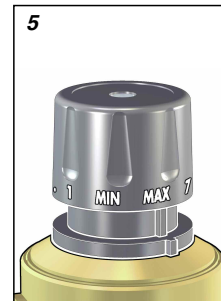
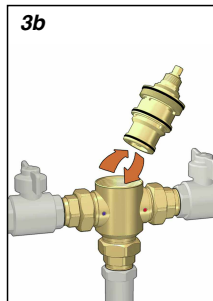
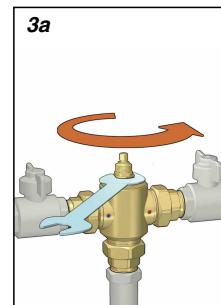
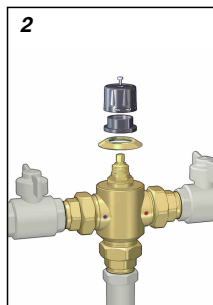

Application diagrams

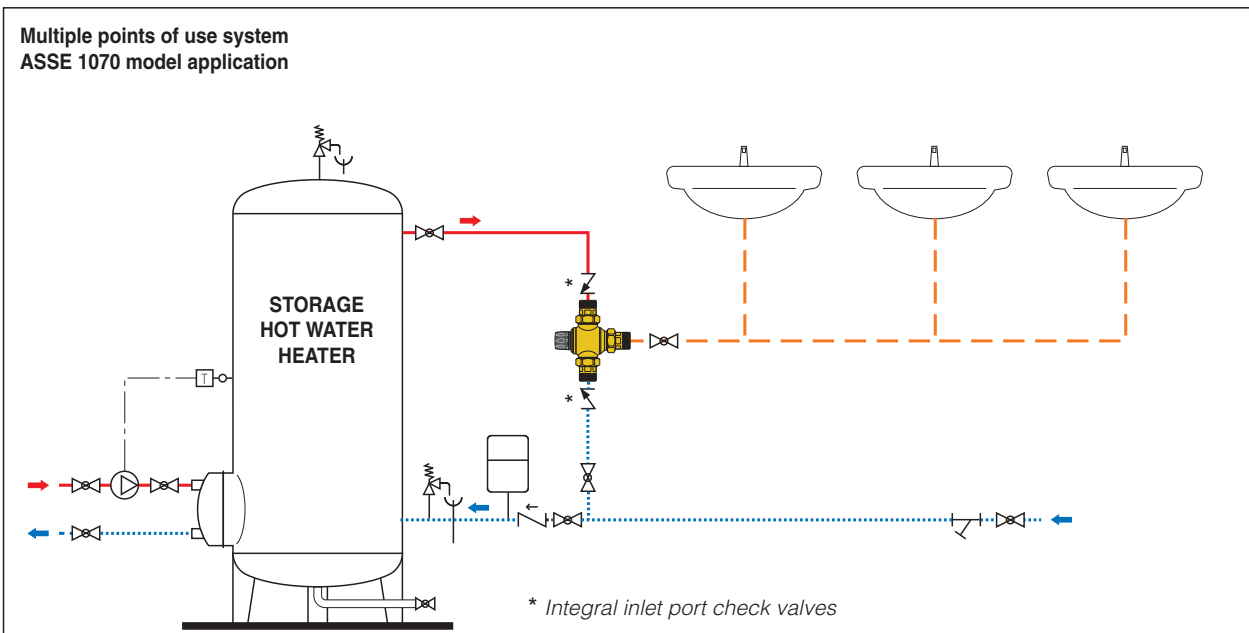
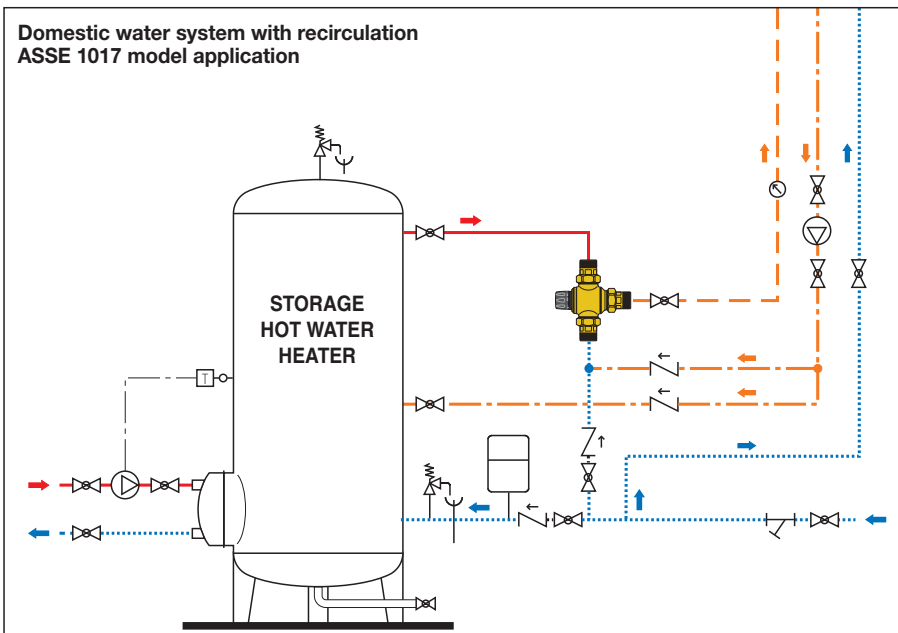
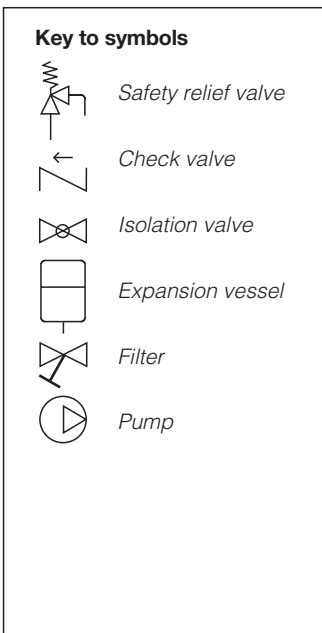
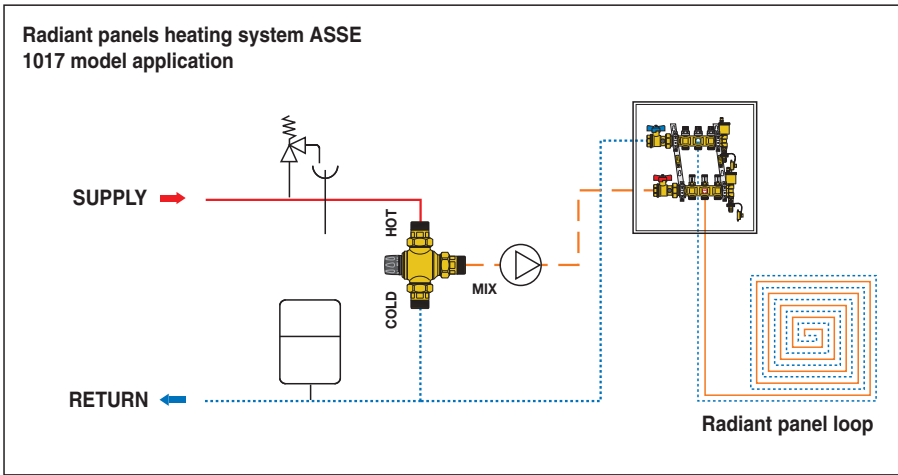
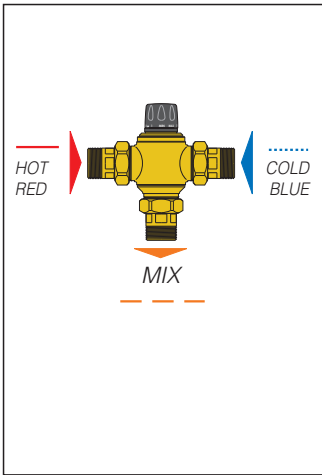

SPECIFICATION SUMMARIES

Code 5230_0A

Adjustable thermostatic mixing valve with replaceable cartridge. Certified to ASSE 1017. Threaded connections from 1" to 2" NPT male with unions. Brass body. Brass cartridge chemical nickel plated. Stainless steel springs. Seals in EPDM. Max. operating temperature 185°F (85°C). Setting range 77 to 153°F (25 to 67°C). Maximum water hardness: 10 grains. Max. working pressure (static) 200 psi. Max. working pressure (dynamic) 70 psi. Tolerance ±5°F. Provided with tamper-proof temperature locking.

Code 5230_6A, 5230_8A

Adjustable thermostatic mixing valve with replaceable cartridge. Certified to ASSE 1017. Sweat connections 3/4", 1" and 1 1/4" with unions. Brass body. Brass cartridge chemical nickel plated. Stainless steel springs. Seals in EPDM. Max. operating temperature 185°F (85°C). Setting range 77 to 153°F (25 to 67°C). Maximum water hardness: 10 grains. Max. working pressure (static) 200 psi. Max. working pressure (dynamic) 70 psi. Tolerance ±5°F. Provided with tamper-proof temperature locking.

Code 5230_5A

Adjustable thermostatic mixing valve with replaceable cartridge. Certified to ASSE 1070. Threaded connections 3/4" and 1" with unions. Brass body. Brass cartridge chemical nickel plated. Stainless steel springs. Seals in EPDM. Max. operating temperature 185°F (85°C). Setting range 77 to 149°F (25 to 65°C). Maximum water hardness: 10 grains. Max. working pressure (static) 200 psi. Max. working pressure (dynamic) 70 psi. Tolerance ±5°F. Provided with tamper-proof temperature locking.

Code 5230_7A

Adjustable thermostatic mixing valve with replaceable cartridge. Certified to ASSE 1070. Sweat connections 3/4" and 1" with unions. Brass body. Brass cartridge chemical nickel plated. Stainless steel springs. Seals in EPDM. Max. operating temperature 185°F (85°C). Setting range 77 to 149°F (25 to 65°C). Maximum water hardness: 10 grains. Max. working pressure (static) 200 psi. Max. working pressure (dynamic) 70 psi. Tolerance ±5°F. Provided with tamper-proof temperature locking.

We reserve the right to change our products and their relevant technical data, contained in this publication, at any time and without prior notice.

